

---

# Lancast®

## Gigabit “twister”™ and SONET “twister”™

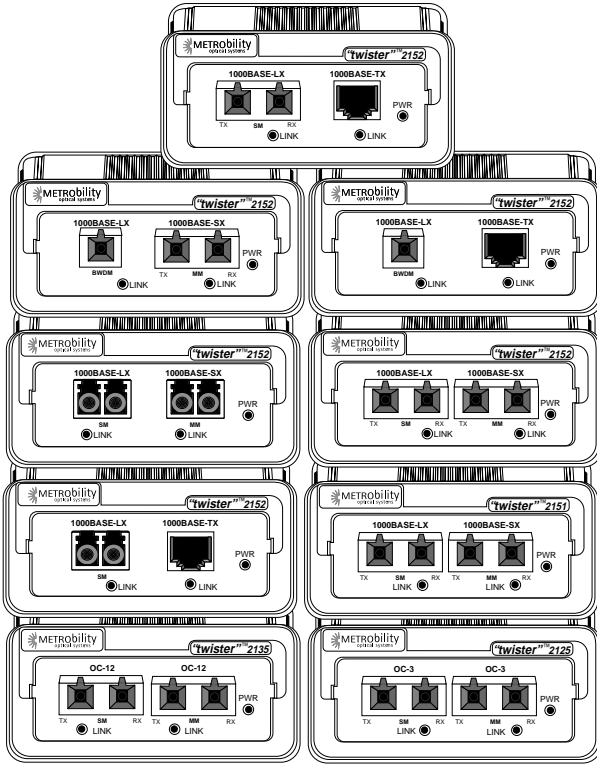

### *Installation & User Guide*

- 2151-AD-01 • 2152-1A-01 • 2152-1D-01 • 2152-1F-01 • 2152-17-01  
 2152-1J-01 • 2152-1K-01 • 2152-1M-01 • 2152-1X-01 • 2152-1Y-01  
 2152-AA-01 • 2152-AD-01 • 2152-AF-01 • 2152-A7-01 • 2152-AJ-01  
 2152-AX-01 • 2152-AY-01 • 2152-DD-01 • 2152-DF-01 • 2152-D7-01  
 2152-DJ-01 • 2152-77-01 • 2152-JJ-01 • 2152-KM-01 • 2125-34-01  
 2125-37-01 • 2135-34-01

## ***Lancast Gigabit “twister” and SONET “twister”***

### **Multimode-to-Singlemode Converter:**

- 2125-34-01 \_\_\_\_ OC-3/STM-1 multimode SC to singlemode SC
- 2125-37-01 \_\_\_\_ OC-3/STM-1 multimode SC to singlemode SC (40km)
- 2135-34-01 \_\_\_\_ OC-12/STM-4 multimode SC to singlemode SC
- 2151-AD-01 \_\_\_\_ 1000Base-SX multimode SC to 1000Base-LX singlemode SC

### **Fiber-to-Fiber Repeater:**

- 2152-AA-01 \_\_\_\_ 1000Base-SX multimode SC to 1000Base-SX multimode SC
- 2152-AD-01 \_\_\_\_ 1000Base-SX multimode SC to 1000Base-LX singlemode SC
- 2152-AF-01 \_\_\_\_ 1000Base-SX multimode SC to 1000Base-MR singlemode SC
- 2152-A7-01 \_\_\_\_ 1000Base-SX multimode SC to 1000Base-LH singlemode SC
- 2152-AJ-01 \_\_\_\_ 1000Base-SX multimode SC to 1000Base-EX singlemode SC
- 2152-AX-01 \_\_\_\_ 1000Base-SX multimode SC to 1000Base-LX singlemode SC 1550/  
1310nm bidirectional wavelength division multiplexed (BWDM)
- 2152-AY-01 \_\_\_\_ 1000Base-SX multimode SC to 1000Base-LX singlemode SC  
1310/1550nm BWDM
- 2152-DD-01 \_\_\_\_ 1000Base-LX singlemode SC to 1000Base-LX singlemode SC
- 2152-DF-01 \_\_\_\_ 1000Base-LX singlemode SC to 1000Base-MR singlemode SC
- 2152-D7-01 \_\_\_\_ 1000Base-LX singlemode SC to 1000Base-LH singlemode SC
- 2152-DJ-01 \_\_\_\_ 1000Base-LX singlemode SC to 1000Base-EX singlemode SC
- 2152-77-01 \_\_\_\_ 1000Base-LH singlemode SC to 1000Base-LH singlemode SC
- 2152-JJ-01 \_\_\_\_ 1000Base-EX singlemode SC to 1000Base-EX singlemode SC
- 2152-KM-01 \_\_\_\_ 1000Base-SX multimode LC to 1000Base-LX singlemode LC

### **Copper-to-Fiber Repeater:**

- 2152-1A-01 \_\_\_\_ 1000Base-TX to 1000Base-SX multimode SC
- 2152-1D-01 \_\_\_\_ 1000Base-TX to 1000Base-LX singlemode SC
- 2152-1F-01 \_\_\_\_ 1000Base-TX to 1000Base-MR singlemode SC
- 2152-17-01 \_\_\_\_ 1000Base-TX to 1000Base-LH singlemode SC
- 2152-1J-01 \_\_\_\_ 1000Base-TX to 1000Base-EX singlemode SC
- 2152-1K-01 \_\_\_\_ 1000Base-TX to 1000Base-SX multimode LC
- 2152-1M-01 \_\_\_\_ 1000Base-TX to 1000Base-LX singlemode LC
- 2152-1X-01 \_\_\_\_ 1000Base-TX to 1000Base-LX singlemode SC 1550/1310nm BWDM
- 2152-1Y-01 \_\_\_\_ 1000Base-TX to 1000Base-LX singlemode SC 1310/1550nm BWDM

This publication is protected by the copyright laws of the United States and other countries, with all rights reserved. No part of this publication may be reproduced, stored in a retrieval system, translated, transcribed, or transmitted, in any form, or by any means manual, electric, electronic, electromagnetic, mechanical, chemical, optical or otherwise, without prior explicit written permission of Metrobility Optical Systems, Inc.

# Table of Contents

## **Lancast Gigabit “twister” and SONET “twister” Installation & User Guide**

<b>Introduction</b> .....	4
<b>Overview</b> .....	5
<b>Installation Guide</b> .....	6
STEP 1: Unpack the “twister” and Accessories .....	6
STEP 2: Choose an Appropriate Location .....	6
STEP 3: Set the DIP Switches .....	7
STEP 4: Connect to the Network .....	8
STEP 5: Apply Power .....	9
<b>User Guide</b> .....	11
LED Indicators .....	11
Link Loss Return (LLR) .....	12
Link Loss Carry Forward (LLCF) .....	13
Copper Loss Carry Forward (CLCF) .....	14
Topology Solutions .....	15
Technical Specifications .....	15
Product Safety, EMC and Compliance Statements .....	18
Warranty and Servicing .....	19

Lancast is a registered trademark; Metrobility Optical Systems, the Metrobility Optical Systems logo, and “twister” are trademarks of Metrobility Optical Systems, Inc.

---

The information contained in this document is assumed to be correct and current. The manufacturer is not responsible for errors or omissions and reserves the right to change specifications at any time without notice.

# *Introduction*

**Thank you for choosing the Lancast “twister”.**

The Lancast Gigabit “twister” and SONET “twister” represent the latest technology available for extending Gigabit Ethernet, OC-3/STM-1 and OC-12/STM-4 networks. Since Metrobility first developed “twister” media conversion, it has set the standard for providing affordable means of integrating mixed media networks. As LANs/WANs grow and evolve, this technology provides an ideal solution for building effective migration strategies.

In addition to the standalone unit, the “twister” is available as an SNMP manageable module for the Lancast Intelligent 7500 chassis and the Radiance central or premise service platforms.

The information in this guide will help you to install and start using your “twister”.

# Overview

The Lancast “twister” provides seamless integration between fiber optic multimode and singlemode segments in Gigabit Ethernet, OC-3/STM-1 or OC-12/STM-4 environments. It supports copper to fiber translation as well as wavelength conversion from 850nm to 1310 or 1550nm, and from 1310nm to 1550nm. With the Lancast “twister”, you can increase your network reach up to 70km on a single segment. For networks that require extended distance support, use the 2152-series repeaters. The repeaters recover incoming data and regenerate the signal, thus allowing multiple hops over any distance.

The Gigabit “twister” and SONET “twister” offer the following key features:

- A Link Loss Return (LLR) switch on each fiber optic port to aid in troubleshooting remote network connections.
- Link Loss Carry Forward (LLCF) functionality on the fiber-to-fiber units or Copper Loss Carry Forward (CLCF) on the copper-to-fiber models. LLCF and CLCF work with LLR in diagnosing network connections.
- Signal recovery that restores data integrity, enabling repetition over unlimited distances. (2152-series only)
- Auto-sensing copper port that eliminates the need for crossover cables.
- Full-duplex support.
- Gigabit Ethernet (1Gbps), OC-3/STM-1 (155Mbps) or OC-12/STM-4 (622Mbps) support.
- A link LED on each port to indicate that the port is receiving idle link signals or a satisfactory level of light.
- IEEE 802.3/ IEEE 802.3z compliance (Gigabit “twister” only).
- Universal desktop power supply (100-240V / 50-60Hz).
- Data transmission over singlemode fiber up to 70km.\*
- Numerous connectivity options, including bidirectional wavelength division multiplexed (BWDM) fiber.

---

\*Actual distance should be calculated based on the actual link loss budget.

# Installation Guide

Follow the simple steps outlined in this section of the guide to install and start using your Lancast “twister”.

## ***Unpack the “twister” and Accessories***

Check that the following components have been included:

- Lancast “twister”
- Power supply
- Power cord
- Four (4) rubber feet

Your order has been provided with the safest possible packaging, but shipping damage does occasionally occur. Inspect your order carefully. If you discover any shipping damage, notify your carrier and follow their instructions for damage and claims. Save the original shipping carton in case return or storage of the unit is necessary.

## ***2 Choose an Appropriate Location***

The “twister” is intended for use in either office or industrial environments. The unit must be located within six (6) feet of the AC power source being used and placed as far away as possible from electrical noise generating equipment such as copiers, electrostatic printers and other motorized equipment. If exposed twisted-pair wiring is used nearby, the wiring should be routed as far away as possible from power cords and data cables to minimize interference.

The unit may be oriented in any manner which allows you to make physical connection to the power supply and leaves a minimum of six (6) inches of space for proper ventilation.

## ***3 Set the DIP Switches***

The Lancast “twister” includes a set of six DIP switches located on the back of the unit. (See figure below.) These switches are used to enable/disable functions and are clearly marked. Unmarked switches are nonfunctional. **LLR1** controls Link Loss Return on Port 1. **LLR2** controls Link Loss Return on Port 2. **LLCF** sets Link Loss Carry Forward on the fiber-to-fiber repeaters (LLCF is nonfunctional on the fiber-to-fiber converters). **CLCF** sets Copper Loss Carry Forward on the copper-to-fiber repeaters.

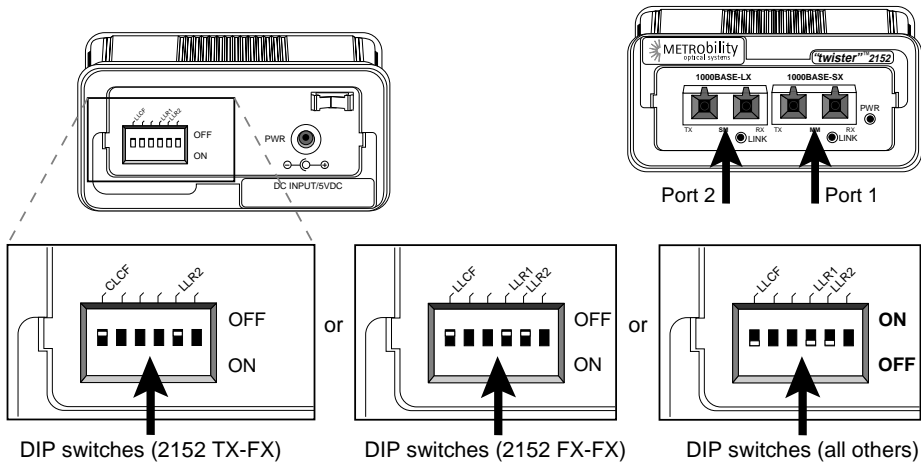

**NOTE:** The ON/OFF positions are not the same on all units.  
By default, all DIP switches are disabled.

### **Link Loss Return (LLR) Switch**

The Lancast “twister” incorporates Link Loss Return functionality as an aid in troubleshooting remote fiber connections. When LLR is enabled on a port, loss of the receive (RX) link at the port disables the transmit (TX) link on the same port. LLR is set independently on each fiber port.

**LLR1** enables/disables Link Loss Return on Port 1, and **LLR2** enables/disables it on Port 2. To enable Link Loss Return, set the LLR switch to the ON position. Set the switch OFF to disable the function. The unit is shipped with LLR disabled. For more information, refer to [Link Loss Return](#) in the User Guide section of this manual.

### **Link Loss Carry Forward (LLCF) Switch**

On the fiber-to-fiber repeaters, Link Loss Carry Forward is provided as an additional aid for troubleshooting remote connections. If LLCF is enabled and the “twister” loses link on one of its receive ports, LLCF inhibits the transmit link out the opposite port.

For example, if LLCF is enabled and the “twister” fails to detect link on Port 2, the “twister” will not transmit link pulses out of Port 1. In doing this, LLCF provides a way to extend the link loss indication beyond a single segment.

LLCF is enabled when the **LLCF** switch is in the ON position. The fiber-to-fiber repeater is shipped with LLCF disabled. On the fiber-to-fiber converters (2151-AD-, 2125-xx- and 2135-34-01), LLCF is always enabled and cannot be disabled. Sliding the **LLCF** switch up and down on these models has no effect. LLCF is not applicable to the copper-to-fiber repeaters. For more information, refer to [Link Loss Carry Forward](#) in the User Guide section of this manual.

### ***Copper Loss Carry Forward (CLCF) Switch***

The copper-to-fiber repeater provides Copper Loss Carry Forward to assist in identifying a lost copper link. When CLCF is enabled and the repeater loses link on its copper port, the card prevents its fiber port from transmitting link pulses. CLCF has no effect on the copper port, which continually transmits link pulses, even if the fiber port loses link.

CLCF is enabled when the **CLCF** switch is in the ON position (down). The unit is shipped with CLCF disabled. For more information, refer to [Copper Loss Carry Forward](#) in the User Guide section of this manual.

# 4

## **Connect to the Network**

The “twister” offers the ease of plug-and-play installation.

### **Twisted-Pair Interface (2152-1x-01 only)**

The twisted-pair port provides an auto-sensing RJ-45 connector that supports a maximum segment length of 100 meters. Use Category 5e cables. Because the port is auto-sensing, crossover cables are not needed.

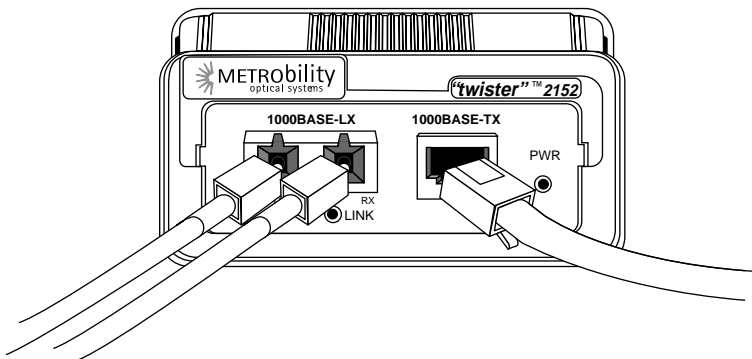



## Fiber Optic Interface

Multimode ports are labeled MM. Singlemode ports are labeled SM. Extended distance ports are labeled LH (Long Haul) or ELH (Extended Long Haul). Each fiber port provides an SC or LC connector. For information about the cable lengths supported by each model, refer to the table in the [Technical Specifications](#) section.

When making connections, be sure that the transmit (TX) optical conductor of the “twister” connects to the receive (RX) optical conductor of the connected device; and be sure that the transmit (TX) optical conductor of the device connects to the receive (RX) optical conductor of the “twister”.

Once power is applied to the unit, correct connectivity can be verified via the LINK LED.

## BWDM Interface

The bidirectional wavelength division multiplexed (BWDM) port provides one singlemode SC connector that supports a maximum segment length of 15km. BWDM units must always be used in complementary pairs. That is, a -1X or -AX must be connected to a -1Y or -AY. The -1X and -AX units are designed to transmit data at a wavelength of 1550nm and receive at 1310nm. Correspondingly, the -1Y and -AY units transmit data at 1310nm and receive at 1550nm.

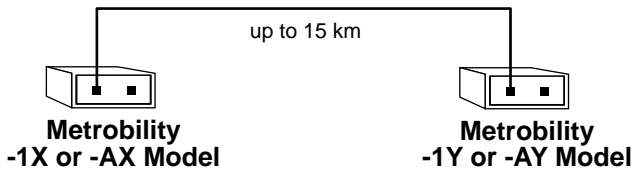

## 5 Apply Power

Power is applied to the “twister” from the desktop power supply. The power supply is equipped with an S760 hollow-type plug for insertion into the DC jack located on the back of the unit and the standard IEC 320-type AC power receptacle. All standalone units use a 100-240V universal desktop power supply.

Connect the DC input jack located on the back of the “twister” before connecting to the AC outlet. Seat the power cord into the strain relief clip to ensure against accidental disconnection.

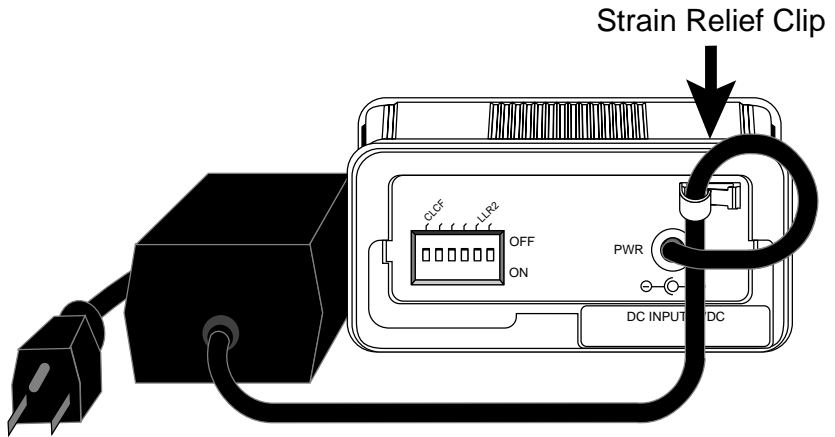

Upon receiving power, the “twister” goes into normal operation mode.

Verify valid connections via the PWR LED on the front panel.

If an additional extension cord is used to connect the power supply to the outlet, follow the guidelines below.

While one end of the AC power cord can be fitted with whatever plug is standard for the country of operation, the end that connects to the “twister” unit’s power supply must have a female plug that fits this type of AC receptacle.

- AC 115V (North American): Use a UL-listed and CSA-certified cord set consisting of a minimum No. 18 AWG, type SVT or SJT three-conductor cord (15 ft. maximum length) and a parallel blade grounding-type attachment plug rated 15A, 125V.
- AC 230V (USA): Use a UL-listed cord set consisting of a minimum No. 18 AWG, type SVT three-conductor cord (15 ft. maximum length) and a Tandem blade grounding-type attachment plug rated 15A, 250V.
- 240V (outside USA): Use a cord set consisting of a minimum No. 18 AWG cord and grounding-type attachment plug rated 15A, 250V. The cord set should have the appropriate safety approvals for the country in which the “twister” is being installed and be marked HAR.

# User Guide

*This section contains more detailed information regarding the operating features of the Lancast “twister”.*

## LED Indicators

The Lancast “twister” provides three LEDs on the front panel for the visible verification of unit status and proper functionality. The LEDs also aid in troubleshooting and overall network diagnosis and management.

When lit, the LEDs indicate the following status:

- **PWR** (power): The unit is powered ON.
- **LINK** (Port 1): Port 1 is receiving idle link signals (if Port 1 is a copper port) or the input light level is satisfactory (if Port 1 is a fiber port).
- **LINK** (Port 2): The input light level is satisfactory on Port 2.

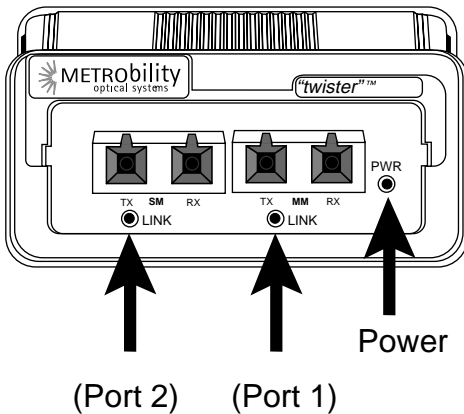

## Link Loss Return (LLR)

The fiber ports on the Lanecast “twister” have been designed with Link Loss Return functionality for troubleshooting remote connections. When LLR is enabled\*, the port’s transmitter (TX) shuts down if its receiver (RX) fails to detect a valid receive link. LLR should only be enabled on one end of a cable and is typically enabled on either the unmanaged or remote device. LLR works in conjunction with LLCF and CLCF.

The diagram below shows a typical network configuration with good link status using two “twister” units for remote connectivity. Note that LLR and LLCF are enabled as indicated in the diagram.

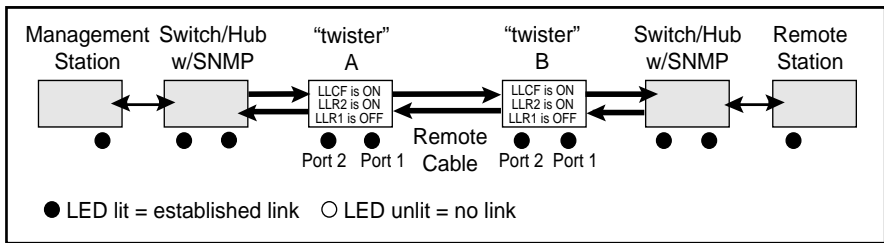

Example: If one of the optical conductors breaks (as shown in the diagram box below), “twister” B, with LLR2 enabled, will return a no-link condition to its link partner, “twister” A. On the fiber-to-fiber models with LLCF also enabled on both units, the no-link condition is carried forward to the switch/hub where a trap is generated to the management station. The network administrator can then determine the source of the loss.

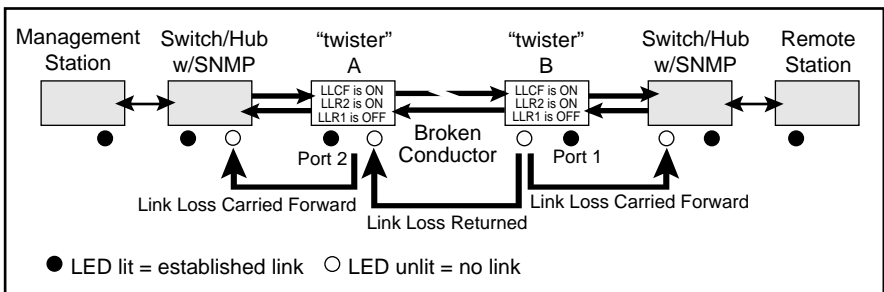

**IMPORTANT:** LLR must not be active on both ends of a configuration. If it is, the link can never be established.

\*Units are shipped with LLR disabled (OFF). On the copper-to-fiber boards, LLR is always enabled on the copper port and cannot be disabled.

# Link Loss Carry Forward (LLCF)

The fiber-to-fiber “twister” units incorporate LLCF functionality to assist in troubleshooting a remote connection. When LLCF is enabled\*, the ports do not transmit link signals until they receive link signals from the opposite port. When a lost link signal is returned to an unmanaged “twister” unit, that lost link must then be carried forward to a managed device (switch/hub) for trap generation. LLCF works in conjunction with LLR.

The diagram below shows a typical network configuration with good link status using two fiber-to-fiber “twister” units for remote connectivity. Note that LLCF is enabled as indicated in the diagram.

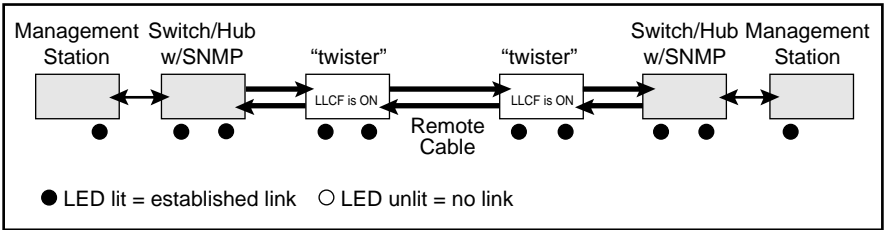

If a connection breaks, the “twister” units will carry that link loss forward to the switch/hub which generates a trap to the management station. The administrator can then determine the source of the problem.

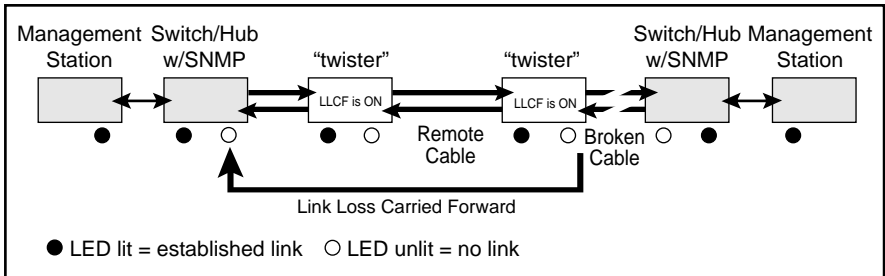
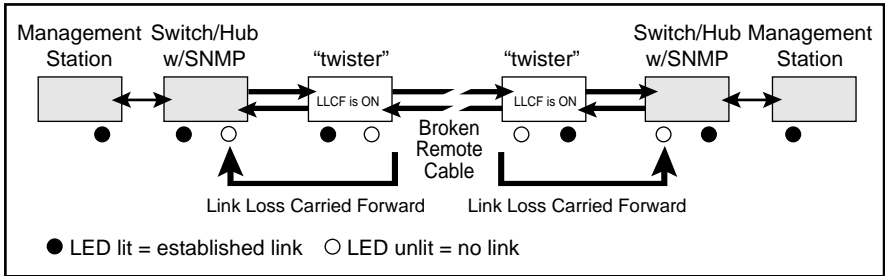

\*Units are shipped with LLCF disabled (DOWN). On the fiber-to-fiber converters (2151-AD-, 2125-xx- and 2135-34-01), LLCF is always enabled and cannot be disabled.

# Copper Loss Carry Forward (CLCF)

The copper-to-fiber “twister” incorporates CLCF for identifying a lost copper connection. When CLCF is enabled\*, the fiber port’s transmitter shuts down if the copper port stops receiving link pulses. However, the copper port continually transmits link signals regardless of whether or not the fiber port detects link.

The diagram below shows a typical network configuration with good link status using two copper-to-fiber “twister” units for remote connectivity. Note that CLCF is enabled as indicated.

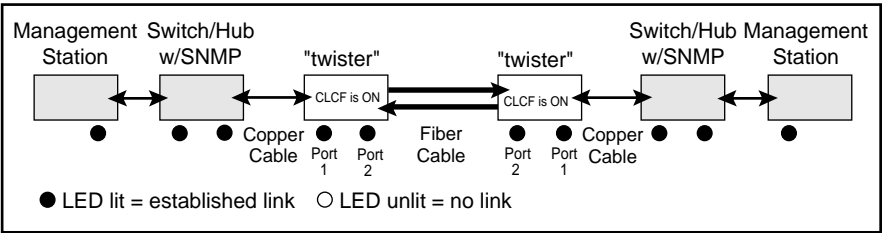

If a copper connection breaks, the “twister” will carry that link loss forward.

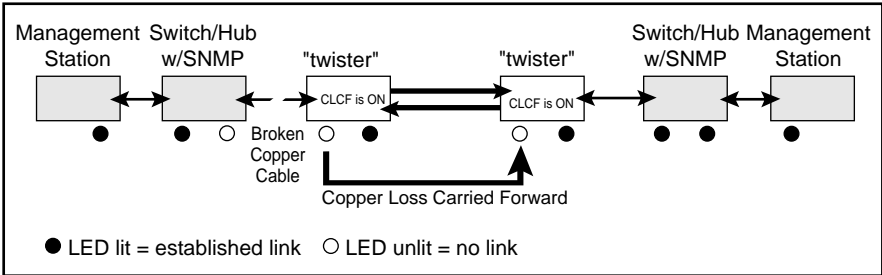

Loss of link at the fiber port is not propagated, as shown in the example below.

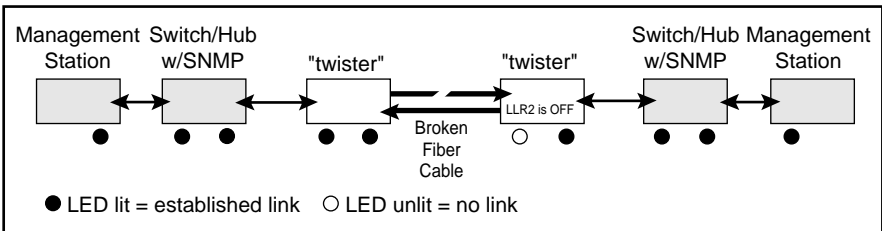

\*Units are shipped with CLCF disabled. CLCF is not applicable to fiber-to-fiber models.

# Topology Solutions

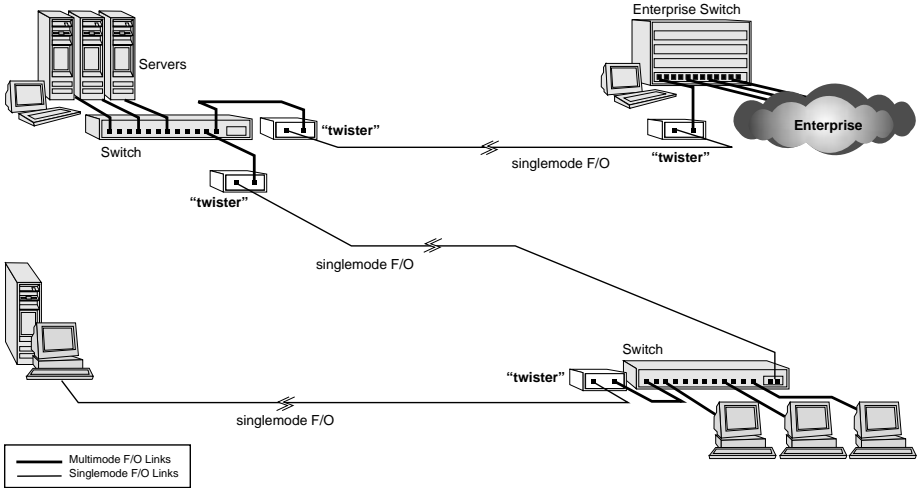

## Technical Specifications

### Twisted-Pair Interface

Connector \_\_\_\_\_ RJ-45  
 Impedance \_\_\_\_\_ 50Ω typical  
 Signal Level Output (differential) \_\_\_\_\_ 0.95 to 1.05V  
 Supported Link Length \_\_\_\_\_ 100m  
 Cable Type \_\_\_\_\_ Category 5e UTP  
 (For EN55024:1998 compliance, use only Category 5e STP cables.)

Gigabit Ethernet (1000Base-T) Crossover Pin Layout					
Plug A			Plug B		
Pin #	Signal	Conductor Color Code	Pin #	Signal	Conductor Color Code
1	BI_DA+	white/green	1	BI_DA+	white/orange
2	BI_DA-	green	2	BI_DA-	orange
3	BI_DB+	white/orange	3	BI_DB+	white/green
4	BI_DC+	blue	4	BI_DC+	white/blue
5	BI_DC-	white/blue	5	BI_DC-	brown
6	BI_DB-	orange	6	BI_DB-	green
7	BI_DD+	white/brown	7	BI_DD+	blue
8	BI_DD-	brown	8	BI_DD-	white/blue

## Fiber Optic Interface

Model	Fiber Type	Wave Length	Cable Length	Cable Size Core/ Clad	RX Input Power (min)	RX Input Power (sat)	TX Output Power (min)	TX Output Power (max)	Power Budget*
2125-34 2125-37	MM	1310nm	2km (rated)	50/125µm	-30dBm	-14dBm	-23.5dBm	-14dBm	6.5dBm
			2km (rated)	62.5/125µm	-30dBm	-14dBm	-20dBm	-14dBm	10dBm
2125-34	SM	1310nm	15km (rated, based on power budget)	9/125µm	-35dBm	-8dBm	-15dBm	-8dBm	20dBm
2125-37	SM (LH)	1310nm	40km (rated)	9/125µm	-35dBm	0dBm	-5dBm	0dBm	30dBm
2135-34	MM	1310nm	500m (rated)	50/125µm	-26dBm	-14dBm	-22.5dBm	-14dBm	3.5dBm
			500m (rated)	62.5/125µm	-26dBm	-14dBm	-20dBm (typical)	-14dBm	6dBm
2135-34	SM	1310nm	15km (rated)	9/125µm	-28dBm	-7dBm	-15dBm	-8dBm	13dBm
2151-AD 2152-AA 2152-AD 2152-AF 2152-A7 2152-AJ 2152-KM 2152-1A 2152-1K	MM (SX)	850nm	220m	62.5/125µm	-17dBm	-3dBm	-9.5dBm	-4dBm	7.5dBm
			500m	50/125µm	-17dBm	-3dBm	-9.5dBm	-4dBm	7.5dBm
2151-AD 2152-AD 2152-DD 2152-DF 2152-D7 2152-DJ 2152-KM 2152-1D 2152-1M	SM (LX)	1310nm	550m	62.5/125µm**	-20dBm	-3dBm	-11.5dBm	-3dBm	8.5dBm
			550m	50/125µm**	-20dBm	-3dBm	-11.5dBm	-3dBm	8.5dBm
			10km	9/125µm	-20dBm	-3dBm	-9.5dBm	-3dBm	10.5dBm
2152-1F 2152-AF 2152-DF	SM (MR)	1310nm	25km	9/125µm	-21dBm	-3dBm	-4dBm	+1dBm	17dBm
2152-A7 2152-D7 2152-77 2152-17	SM (LH)	1550nm	40km	9/125µm	-21dBm	-3dBm	-4dBm	+1dBm	17dBm
2152-AJ 2152-DJ 2152-JJ 2152-1J	SM (EX)	1550nm	70km	9/125µm	-23dBm	-3dBm	-3dBm	+2dBm	20dBm

\* Power Budget = [TX Output Power (min)] — [RX Input Power (min)]

\*\* Using multimode cable with a singlemode transducer.



## ***BWDM Interface***

Connector \_\_\_\_\_ SC  
Supported Link Length \_\_\_\_\_ up to 15km  
Cable Type \_\_\_\_\_ 9/125 $\mu$ m F/O  
Output Power \_\_\_\_\_ -10 dBm to -3 dBm  
RX Input Sensitivity \_\_\_\_\_ -17 dBm minimum  
Wavelength (2152-1X-01, 2152-AX-01)  
    Transmitter \_\_\_\_\_ 1550 nm  
    Receiver \_\_\_\_\_ 1310 nm  
Wavelength (2152-1Y-01, 2152-AY-01)  
    Transmitter \_\_\_\_\_ 1310 nm  
    Receiver \_\_\_\_\_ 1550 nm

## ***Data Rate***

Data Rate \_\_\_\_\_ 1Gbps (Gigabit Ethernet)  
                  \_\_\_\_\_ 155Mbps (OC-3/STM-1), 622Mbps (OC-12/STM-4)

## ***Power Supply***

Input \_\_\_\_\_ 100-240V AC 50-60 Hz  
Output \_\_\_\_\_ +5V DC @ 2 A

## ***Environmental***

Operating Temperature \_\_\_\_\_ 0° to 55° C  
Storage Temperature \_\_\_\_\_ -25° to 70° C  
Relative Humidity \_\_\_\_\_ 5% to 95% non-condensing  
Physical Case \_\_\_\_\_ Fully enclosed metal construction  
Dimensions \_\_\_\_\_ 4.83" L x 3.26" W x 1.71" H  
                  \_\_\_\_\_ 12.3 cm x 8.3 cm x 4.3 cm  
Weight (including power supply) \_\_\_\_\_ 3 lbs, 1.36 kg

## ***Regulatory***

Compliance \_\_\_\_\_ IEEE 802.3 Sec. 14, IEEE 802.3z

## ***Product Safety, EMC and Compliance Statements***

This equipment complies with the following requirements:

- UL
- CSA
- EN60950 (safety)
- FCC Part 15, Class A
- EN55022 Class A (emissions)
- DOC Class A (emissions)
- EN55024: 1998 (immunity)
- IEC 825-1 Classification
- Class 1 Laser Product

This product shall be handled, stored and disposed of in accordance with all governing and applicable safety and environmental regulatory agency requirements.

The following *FCC* and *Industry Canada* compliance information is applicable to North American customers only.

### ***USA FCC Radio Frequency Interference Statement***

This equipment has been tested and found to comply with the limits for a Class A digital device, pursuant to Part 15 of the FCC Rules. These limits are designed to provide reasonable protection against harmful interference when the equipment is operated in a commercial environment. This equipment generates, uses and can radiate radio frequency energy, and if not installed and used in accordance with the instruction manual, may cause harmful interference to radio communications. Operation of this equipment in a residential area is likely to cause harmful interference in which case the user will be required to correct the interference at his own expense.

***Caution:*** *Changes or modifications to this equipment not expressly approved by the party responsible for compliance could void the user's authority to operate the equipment.*

### ***Canadian Radio Frequency Interference Statement***

This Class A digital apparatus meets all requirements of the Canadian Interference-Causing Equipment Regulations.

Cet appareil numérique de la classe A respecte toutes les exigences du Règlement sur le matériel brouilleur du Canada.

## **Warranty and Servicing**

### ***Three-Year Warranty for the Lancast “twister”***

Metrobility Optical Systems, Inc. warrants that every Lancast “twister” product will be free from defects in material and workmanship for a period of THREE YEARS. This warranty covers the original user only and is not transferable. Should the unit fail at any time during this warranty period, Metrobility will, at its sole discretion, replace, repair, or refund the purchase price of the product. This warranty is limited to defects in workmanship and materials and does not cover damage from accident, acts of God, neglect, contamination, misuse or abnormal conditions of operation or handling, including overvoltage failures caused by use outside of the product’s specified rating, or normal wear and tear of mechanical components.

To establish original ownership and provide date of purchase, complete and return the registration card or register the product online at [www.metrobility.com](http://www.metrobility.com). If product was not purchased directly from Metrobility, please provide source, invoice number and date of purchase.

To return a defective product for warranty coverage, contact Metrobility Customer Service for a return materials authorization (RMA) number. Send the defective product postage and insurance prepaid to the address provided to you by the Metrobility Technical Support Representative. Failure to properly protect the product during shipping may void this warranty. The Metrobility RMA number must be clearly on the outside of the carton to ensure its acceptance.

Metrobility will pay return transportation for product repaired or replaced in-warranty. Before making any repair not covered by the warranty, Metrobility will estimate cost and obtain authorization, then invoice for repair and return transportation. Metrobility reserves the right to charge for all testing and shipping costs incurred, if test results determine that the unit is without defect.

This warranty constitutes the buyer’s sole remedy. No other warranties, such as fitness for a particular purpose, are expressed or implied. Under no circumstances will Metrobility be liable for any damages incurred by the use of this product including, but not limited to, lost profits, lost savings, and incidental or consequential damages arising from the use of, or inability to use, this product. Authorized resellers are not authorized to extend any other warranty on Metrobility’s behalf.

### **Product Manuals**

The most recent version of this manual is available online at  
<http://www.metrobility.com/support/manuals.htm>

To obtain additional copies of this manual, contact your reseller, or call  
1.877.526.2278 or 1.603.880.1833

### **Product Registration**

To register your product, go to  
<http://www.metrobility.com/support/registration.cfm>

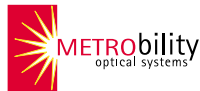

25 Manchester Street, Merrimack, NH 03087  
tel: 1.603.880.1833 • fax: 1.603.594.2887  
[www.metrobility.com](http://www.metrobility.com)